

# ***PARMA***<sup>®</sup>

---

## **Forage Box OPERATOR'S/PARTS MANUAL**

Manual Number 030609-BOX

---

# ***PARMA COMPANY***

P.O. BOX 190  
PARMA, IDAHO 83660  
PHONE (208) 722-5116 FAX (208) 722-6012  
E-Mail: [www.parmacompany.com](http://www.parmacompany.com)



## TABLE OF CONTENTS

BOLT TORQUE.....	15
CUSTOMER & DEALER CHECKLIST.....	1
INSTALLATION INSTRUCTIONS.....	16
INTRODUCTION.....	1
LUBRICATION & SERVICE SCHEDULE.....	13
MAINTENANCE & SERVICE INFORMATION.....	12
PARTS REPLACEMENT SECTION.....	18
SAFETY PRECAUTIONS.....	4
SAFETY SIGN LOCATIONS.....	6
SAFETY BEFORE OPERATING.....	8
SAFETY DURING OPERATION.....	8
SAFETY DURING HIGHWAY AND TRANSPORT OPERATIONS.....	10
SAFETY WHILE PERFORMING MAINTENANCE.....	11
STARTUP PROCEDURE.....	17
TROUBLE SHOOTING.....	14
WARRANTY POLICY.....	3



## INTRODUCTION

This manual has been prepared to acquaint you with the operation and maintenance of your **PARMA Forage Box**, and to provide important safety information. We urge you to read this manual carefully. The recommendations will help assure the safe and trouble free operation of your machine.

When it comes to service, keep in mind that your dealer knows your Forage Box well and is interested in your complete satisfaction. Your dealer invites you to call him for your service needs both during and after the warranty period.

We thank you for choosing a PARMA product and want to assure you of our continuing interest in your satisfaction. You have purchased a very good machine and with proper care it will give you good service.

## CUSTOMER AND DEALER CHECKLIST

After the machine has been completely assembled, inspect it thoroughly to be certain it is in operating condition before delivering it to a customer. The following checklist is a reminder of points to inspect. Check off each item as it is found satisfactory or after proper adjustment is made.

### PRE-DELIVERY:

- Check all bolts and nuts to be sure they are tight.
- Make sure all bearing lock collars are set correctly and tightened.
- Inspect and, if necessary, grease at all lubrication points; making sure all bearings are taking grease.
- Check all moving parts for smooth operation.
- Check to see that all hydraulic fittings and cylinders are tight and free of leaks.

### DELIVERY:

- Complete the Delivery and Warranty Registration Forms, listing serial number of machine.
- Have the dealer and customer sign the form. Explain warranty policy on the Warranty Registration Form.
- Show the customer how to operate the Forage Box.
- Explain adjustments.
- Explain the importance of proper lubrication.

**DELIVERY CHECKLIST** continued.

- \_\_\_ Give the operator's manual to the customer and ask him to familiarize himself with all sections of it.

**BEFORE EACH SEASON:**

- \_\_\_ Check all adjustable components for correct setting.
- \_\_\_ Perform complete lubrication of machine.
- \_\_\_ With equipment operating, observe operation of moving parts. Watch for faulty operation, overheated bearings, and unusual sounds.
- \_\_\_ Read the safety precautions.
- \_\_\_ Read the operating instructions.
- \_\_\_ Perform daily checklist.

**DAILY CHECKLIST:**

- \_\_\_ Lubricate (as instructed) all lubrication points (see pg.13).

## WARRANTY POLICY

PARMA COMPANY warrants to each purchaser from an authorized dealer of new equipment manufactured by PARMA COMPANY, that such equipment is, at the time of delivery to such purchaser, free from defects in material and workmanship under normal use, if serviced in accordance with the recommendations of the Operator's Manual. All PARMA COMPANY'S *harvesting equipment products* are warranted for 120 days from the first day of use or 800 acres, whichever occurs first. All PARMA COMPANY *soil preparation* products are warranted for 120 days from first day of use or 1600 acres, whichever occurs first. All PARMA COMPANY *water and waste pump products* are warranted for one year from date of purchase. All PARMA COMPANY *forage* products are warranted for one year from date of purchase. Warranty on defective parts purchased by PARMA COMPANY or produced by other manufacturers for PARMA COMPANY may be allowed only after the approval of the vendor or manufacturer.

PARMA COMPANY'S obligation under this warranty is limited to repairing, or at it's option, replacing any part, that in PARMA COMPANY'S judgment, proved defective. Under the terms of the warranty, PARMA COMPANY assumes no responsibility for labor or travel costs involved in removal of defective parts, of installation of new parts, or of any shop supplies or service charges.

All warranty claims are to be initiated through the authorized PARMA COMPANY dealer and must be submitted within 30 days of the date of failure. PARMA COMPANY may ask for defective parts to be returned to the factory; therefore, hold all warranty claim parts until advised if the parts are needed by your dealer.

To make the warranty effective, the owner's **Warranty Registration Form** must be on file at PARMA COMPANY, Parma, Idaho at the time of receipt of the warranty claim.

## DISCLAIMER OF ALL OTHER WARRANTIES AND CONSEQUENTIAL DAMAGES

THE FOREGOING IS IN LIEU OF ALL OTHER WARRANTIES, WHETHER EXPRESSED OR IMPLIED, INCLUDING ANY IMPLIED WARRANTY OF MERCHANTABILITY OR FITNESS FOR A PARTICULAR PURPOSE, AND THERE ARE NO WARRANTIES, WHICH EXTEND BEYOND THE DESCRIPTION OF THE PRODUCTS. THE LIABILITY OF PARMA COMPANY IS EXPRESSLY LIMITED TO REPAIRING, OR AT ITS OPTION, REPLACING ANY PART THAT IS RETURNED, TRANSPORTATION PREPAID, TO PARMA COMPANY, PARMA, IDAHO, THAT IN PARMA'S JUDGEMENT PROVED DEFECTIVE DURING THE WARRANTY PERIOD. NO REPRESENTATIVE OF PARMA COMPANY, NO DEALER OR DEALER'S REPRESENTATIVE OR ANY OTHER PERSON HAS AUTHORITY TO WAIVE, ALTER, VARY OR ADD TO THE TERMS HEREOF WITHOUT PRIOR APPROVAL IN WRITING SIGNED BY AN OFFICER OF PARMA COMPANY. PARMA COMPANY WILL NOT BE LIABLE FOR ANY OTHER EXPENSE, INJURY, LOSS OR DAMAGE WHETHER DIRECT OR CONSEQUENTIAL, ARISING IN CONNECTION WITH THE SALE OR USE OF OR INABILITY TO USE, ANY PRODUCT OF THE COMPANY FOR ANY PURPOSE.

# SAFETY PRECAUTIONS

**TAKE NOTE! THIS SAFETY ALERT SYMBOL FOUND THROUGHOUT THIS MANUAL IS USED TO CALL YOUR ATTENTION TO INSTRUCTIONS INVOLVING YOUR PERSONAL SAFETY AND THE SAFETY OF OTHERS. FAILURE TO FOLLOW THESE INSTRUCTIONS CAN RESULT IN INJURY OR DEATH.**



THIS SYMBOL MEANS

**-ATTENTION!**

**-BECOME ALERT!**

**- YOUR SAFETY IS INVOLVED!**

## **SIGNAL WORDS:**

Note the use of the signal words **DANGER**, **WARNING** and **CAUTION** with the safety messages. The appropriate signal word for each has been selected using the following guidelines:

**DANGER:** Indicates an imminently hazardous situation that, if not avoided, will result in death or serious injury. This signal word is to be limited to the most extreme situations typically for machine components for which functional purposes cannot be guarded.

**WARNING:** Indicates a potentially hazardous situation that, if not avoided, could result in death or serious injury, and includes hazards that are exposed when guards are removed. It may also be used to alert against unsafe practices.

**CAUTION:** Indicates a potentially hazardous situation that, if not avoided, may result in minor or moderate injury. It may also be used to alert against unsafe practices.

If you have questions not answered in this manual or require additional copies or the manual is damaged, please contact your dealer.

**SAFETY.... YOU CAN LIVE WITH IT**





## SAFETY.... YOU CAN LIVE WITH IT



### EQUIPMENT SAFETY GUIDELINES

Safety of the operator is one of the main concerns in designing and developing a new piece of equipment. Designers and manufacturers build in as many safety features as possible. However, every year many accidents occur which could have been avoided by a few seconds of thought and a more careful approach to handling equipment. You, the operator, can avoid many accidents by observing the following precautions in this section. To avoid personal injury, study the following precautions and insist those working with you, or for you, follow them.

In order to provide maximum safety to the operator or other persons around this machine, various shields and covers have been installed. Keep all shields and covers in place. If shield removal becomes necessary for repairs or any other reason, replace the shield prior to use.

Replace any CAUTION, WARNING, DANGER or instruction safety decal that is not readable or is missing. Location of such decals is indicated in this manual.

Do not attempt to operate this equipment under the influence of drugs or alcohol.

Review the safety instructions with all users annually.

This equipment is dangerous to children and persons unfamiliar with its operation. The operator should be a responsible adult familiar with farm machinery and trained in this equipment's operations. **Do not allow persons to operate or assemble this unit until they have read this manual and have developed a thorough understanding of the safety precautions and of how it works.**

Do not paint over, remove or deface any safety signs or warning decals on your equipment. Observe all safety signs and practice the instructions on them.

Never exceed the limits of a piece of machinery. If its ability to do a job, or to do so safely is in question – **DON'T TRY IT.**



### LIGHTING AND MARKING

It is the responsibility of the customer to know the lighting and marking requirements of the local highway authorities and to install and maintain the equipment to provide compliance with the regulations. Add extra lights when transporting at night or during periods of limited visibility.

Lighting kits are available from your dealer or from the manufacturer.

## SAFETY SIGN LOCATIONS

The types of Safety Sign on the equipment are shown below. Their locations are shown on page 12 of the parts section of this manual. Good safety requires that you familiarize yourself with the various Safety Signs, the type of warning and the area, or particular function related to that area that requires your SAFETY AWARENESS.

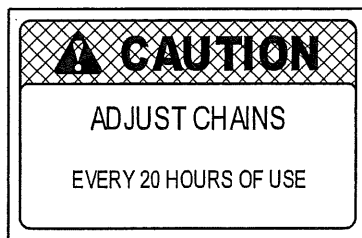

Part #700489

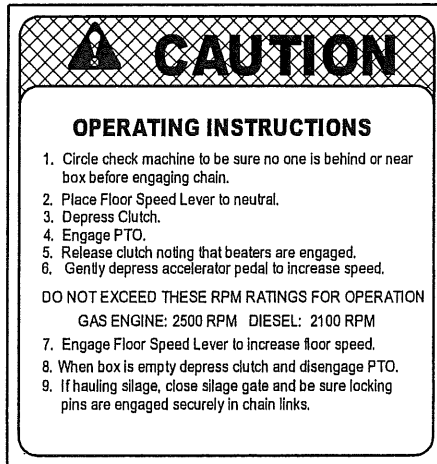

Part #700490

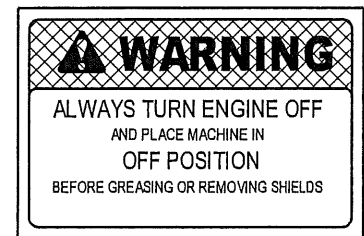

Part #700500

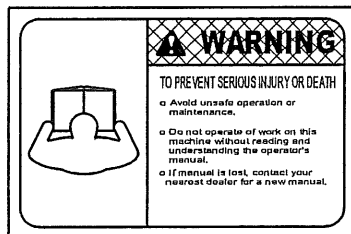

Part #700503

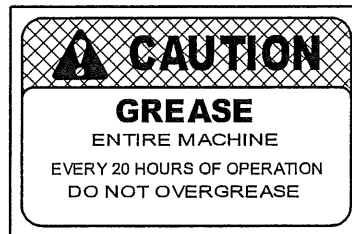

Part #700491

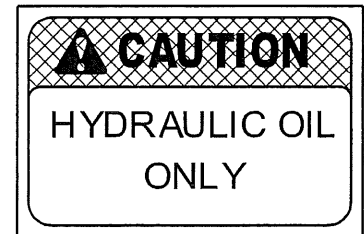

Part #700488



Part #700493



Part #700502

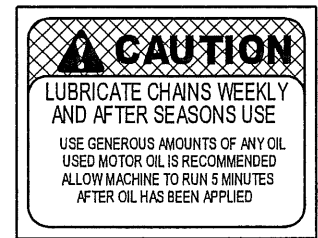

Part #700492

**REMEMBER:** if Safety Signs have been damaged, removed, become illegible or parts replaced without decals, new decals must be applied. New decals are available from your authorized dealer or manufacturer.



## **SAFETY SIGN CARE**

- Keep safety signs clean and legible at all times
- Replace safety signs that are missing or have become illegible
- Replaced parts that displayed a safety sign should also display the current sign
- Safety signs are available from your Dealer Parts Department or the Manufacturer

### **How to Install Safety Signs:**

- Be sure that the installation area is clean and dry
- Decide on the exact position before you remove the backing paper
- Remove the smallest portion of the split backing paper
- Align the decal over the specified area and carefully press the small portion with the exposed sticky backing in place
- Slowly peel back the remaining paper and carefully smooth the remaining portion of the decal in place
- Small air pockets can be pierced with a pin and smoothed out using the piece of decal backing paper



## **TIRE SAFETY**

- Failure to follow proper procedures when mounting a tire on a wheel or rim can produce an explosion which may result in serious injury or death
- Do not attempt to mount a tire unless you have the proper equipment and experience to do the job
- Inflating or servicing tires can be dangerous. Whenever possible, trained personnel should be called to service and/or mount tires
- Always order and install tires and wheels with appropriate capacity to meet or exceed the anticipated weight to be placed on the equipment.



## **REMEMBER!**

**Your best assurance against accidents is a careful and responsible operator. If there is any portion of this manual or function you do not understand, contact your local authorized dealer or the manufacturer.**



### **BEFORE OPERATING:**

- Carefully study and understand this manual
- Do not wear loose-fitting clothing which may catch in moving parts
- Always wear protective clothing and substantial shoes
- It is recommended that suitable protective hearing and (eye protection) sight protectors be worn
- The operator may come in contact with certain materials which may require specific safety equipment, relative to the handling of such materials (examples: extreme dust, molds, fungus, bulk fertilizers, etc)
- Keep wheel lug nuts or bolts tightened to specified torque
- Assure that agricultural implement tires are inflated evenly
- Inspect the unit for any loose bolts, worn parts or cracked welds, and make necessary repairs. Follow the maintenance safety instructions included in this manual
- Be sure that there are no tools lying on or in the equipment
- Do not use the unit until you are sure that the area is clear, especially children and animals
- Because it is possible that this equipment may be used in dry areas or in the presence of combustibles, special precautions should be taken to prevent fires and fire fighting equipment should be readily available
- Don't hurry the learning process or take the unit for granted. Ease into it and become familiar with you new equipment
- Practice operation of your equipment and its attachments. Completely familiarize yourself and other operators with its operation before using
- Make sure that the brakes are evenly adjusted (if equipped with brakes)



### **DURING OPERATION:**

- **NO PASSENGERS ALLOWED** – Do not allow any passengers to ride on the equipment at any time unless they are located inside the truck cab with their seat belt fastened
- Keep hands and clothing clear of moving parts
- Do not clean, lubricate or adjust your equipment while it is in motion
- When halting operation, even periodically, set the truck brakes, disengage the PTO, shut off the engine and **remove the ignition key**



### DURING OPERATION cont....

- Be especially observant of the operating area and terrain – watch for holes, rocks or other hidden hazards. Always inspect the area prior to operation
  - **DO NOT** operate near the end of drop-offs or banks
  - **DO NOT** operate near the end of drop-offs or banksOperate up and down (not across) intermediate slopes. Avoid sudden starts and stops
- Pick the most level route when transporting across fields. Avoid the edges of ditches or gullies and steep hillsides
- Be extra careful when working on inclines
- Periodically clear the equipment of brush, twigs or other materials to prevent buildup of dry combustible materials
- Avoid overhead wires or other obstacles. Contact with overhead lines could cause serious injury or death
- Avoid loose fill, rocks and holes; they can be dangerous for equipment operation or movement
- Allow for unit length when making turns
- Do not walk or work under raised components or attachments unless securely positioned and blocked
- Keep all bystanders, pets and livestock clear of the work area
- As a precaution, always recheck the hardware on equipment following every 100 hours of operation. Correct all problems. Follow the maintenance safety procedures
- Operate the truck from the operator's seat only



### FOLLOWING OPERATION:

- Following operation, set the brakes, disengage the PTO and all power drives, shut off the engine and **remove the ignition keys**
- Store the unit in an area away from human activity
- Do not park equipment where it will be exposed to livestock for long periods. Damage and livestock injury could result
- Do not permit children to play on or around the stored unit
- Make sure all parked machines are on a hard, level surface and engage all safety devices
- Wheel chocks may be needed to prevent unit from rolling



## HIGHWAY AND TRANSPORT OPERATIONS:

- Adopt safe driving practices:

Always drive at a safe speed relative to local conditions and ensure that your speed is low enough for an emergency to stop to be safe and secure. Keep speed to a minimum

Reduce speed prior to turns to avoid the risk of overturning

Avoid sudden uphill turns on steep slopes

Always keep the truck in gear to provide engine braking when going downhill. Do not coast

**Do not drink and drive!**

- Comply with state and local laws governing highway safety and movement of farm machinery on public roads
- Use approved accessory lighting flags and necessary warning devices to protect operators of other vehicles on the highway, during daylight and nighttime transport, in accordance with State Department of Transportation specifications. Various safety lights and devices are available from your Dealer
- The use of flashing amber lights is acceptable in most localities. However, some localities prohibit their use. Local laws should be checked for all highway lighting and marking requirements
- Be a safe and courteous driver. Always yield to oncoming traffic in all situations, including narrow bridges, intersections, etc
- Be observant of bridge loading ratings. Do not cross bridges rated lower than the gross weight at which you are operating
- Watch for obstructions overhead and to the side while transporting
- Always operate equipment in a position to provide maximum visibility at all times. Make allowances for increased length and weight of the equipment when making turns, stopping the unit, etc



## **PERFORMING MAINTENANCE:**

- Good maintenance is your responsibility. Poor maintenance is an invitation to trouble
- Make sure there is plenty of ventilation. Never operate the engine in a closed building. The exhaust fumes may cause asphyxiation
- Before working on this machine, stop, set the brakes, disengage the PTO and all power drives, shut off the engine and **remove the ignition keys**
- Be certain all moving parts on attachments have come to a complete stop before attempting to perform maintenance
- **Always** use a safety support and block the wheels. Never use a jack to support the machine
- Always use the proper tools or equipment for the job at hand
- Use extreme caution when making adjustments
- Follow the torque chart in this manual when tightening bolts and nuts
- Never use your hands to locate a hydraulic leak on attachments. Use a small piece of cardboard or wood. Hydraulic fluid escaping under pressure can penetrate the skin
- When disconnecting hydraulic lines, shut off hydraulic supply and relieve all hydraulic pressure
- Openings in the skin and minor cuts are susceptible to infection from hydraulic fluid. **If injured by escaping hydraulic fluid, see a doctor at once. Gangrene can result. Without immediate medical treatment, serious infection and reactions can occur**
- Replace **all shields and guards** after servicing and before moving
- After servicing, be sure all tools, parts and service equipment are removed
- Do not allow grease or oil to build up on any step or platform
- Never replace hex bolts with less than grade five bolts unless otherwise specified. Refer to bolt torque chart for head identification marking
- Where replacement parts are necessary for periodic maintenance and servicing, genuine factory replacement parts must be used to restore your equipment to original specifications. The manufacturer will not claim responsibility for use of unapproved parts and/or accessories and other damages as a result of their use
- If equipment has been altered in any way from original design, the manufacturer does not accept any liability for injury or warranty
- A fire extinguisher and first aid kit should be kept readily accessible while performing maintenance on this equipment

# MAINTENANCE/SERVICE INFORMATION

## Bearings

- Inspect bearings for wear and heat every 100 hours
- **The Pillow Block and Flanged bearing units are factory pre-lubricated and, therefore, do not require supplemental grease before service life begins. Re-lubrication, when administered correctly, can increase the life of a bearing substantially. Bearing manufacturers recommend that all these bearings be greased daily to weekly, considering the environmental condition that these harvesters are exposed to. NOTE: Over lubrication is a major cause of bearing failures. Please re-lubricate conservatively. When selecting a bearing lubricant, use any lithium-based NLGI #2 grease**



**Always perform maintenance with machine stopped and engine shut off**

## Hydraulic Oil

- Inspect oil level every 20 hours
- Replace oil every season or sooner if conditions are extreme
- Dispose of oil in a responsible manner. Consult local authorities for disposal site
- Recommended hydraulic oil is Texaco Rando Superflow AZ or equivalent: \*
  - \*Chevron AW MV 32
  - \*Mobil DTE 13M

## Floor Chain Lubrication

- Chain should be cleaned and lubricated weekly
- Use generous amounts of oil.
- Allow machine to run five minutes after oil has been applied
- Re-tension chain at this time



**Never enter machine while it is running**

## Chain Tension

Chain tension adjusters are at the front of the box, behind the truck cab

- Inspect chain for wear and tension weekly
- Tension chains to a deflection of 6-7" at center span
- Loose chains cause excessive wear and damage
- Chains that are too tight accelerate wear



**Never enter machine while it is running**

## Seasonal Storage

- Perform all service recommended in the Maintenance Schedule
- Lubricate chains
- Inspect box for wear and damage
- Keep dry during storage



## LUBRICATION & SERVICE SCHEDULE

	Every 20 Hrs		Every 100 hrs		Seasonal	
	O	X			O	X
Floor Chain	O	X			O	X
Drive Chain			O	X	O	X
Bearings			O	X	O	X
All Bolts & Fasteners				X		X
Frame						X
Wheel Nuts		X				X
Hydraulic Fluid		X			O	
Filter Element				O		
Hydraulic Cylinders				X		X
Lights & Wires		X				X
Hydraulic Lines						X
Guards		X				X
Rear Doors		X				X

O = Service and lubricate as recommended

X = Inspect for wear or damage

**NOTE: Service and lubrication does not apply to truck – Application to Box only**



**Factory recommends that ALL BOLTS AND FASTENERS BE RE-TORQUED AFTER THE FIRST 20 HOURS OF USE**



**AVOID INJURY: Never service machine while running. Follow safety procedures in this manual for service and maintenance**

# TROUBLE SHOOTING

<u>Problem</u>	<u>Possible Cause</u>	<u>Possible Solution</u>
Floor not moving	<ol style="list-style-type: none"> <li>1. Oil line punctured</li> <li>2. Load too heavy</li> <li>3. Relief valve malfunction</li> <li>4. Control valve malfunction</li> <li>5. Hydraulic motor stall, or malfunction</li> <li>6. Hydraulic pump malfunction</li> <li>7. Chain frozen down</li> </ol>	<ol style="list-style-type: none"> <li>1. Replace broken hose</li> <li>2. Reduce load size</li> <li>3. Adjust relief valve to 3500-PSI maximum, replace valve, replace pump</li> <li>4. Contact local Dealer, replace valve</li> <li>5. Replace motor, replace pump</li> <li>6. Call local Dealer, replace pump</li> <li>7. Allow machine to warm up</li> </ol>
Rear doors won't close (air operation)	<ol style="list-style-type: none"> <li>1. Air line leak</li> <li>2. Air pressure too low</li> <li>3. Solenoid valve malfunction</li> <li>4. Truck is on an upward incline</li> </ol>	<ol style="list-style-type: none"> <li>1. Inspect and replace air line</li> <li>2. Adjust air pressure regulator</li> <li>3. Check electrical contacts, Replace solenoid valve</li> <li>4. Place truck on level ground before closing</li> </ol>
Rear doors won't close (hydraulic operation)	<ol style="list-style-type: none"> <li>1. Hydraulic lines leak</li> <li>2. Electric controls disconnected or shorted</li> <li>3. Frozen down</li> <li>4. Relief Valve malfunction</li> <li>5. Hydraulic pump unit malfunction</li> <li>6. Control valve malfunction</li> </ol>	<ol style="list-style-type: none"> <li>1. Inspect and replace broken hose</li> <li>2. Inspect and replace faulty wires or switch</li> <li>3. Allow machine to warm up</li> <li>4. Adjust relief valve to 400-PSI maximum, replace relief valve</li> <li>5. Adjust relief valve, replace pump</li> <li>6. Contact local Dealer, replace valve</li> </ol>

# BOLT TORQUE

## Checking Bolt Torque

The table shown below gives correct torque values for various bolts and cap screws. Tighten all bolts to the torques specified in the chart unless otherwise noted. Check tightness of bolts periodically, using bolt torque chart as a guide. Replace hardware with the same strength bolt

## Torque specifications

Bolt Size	SAE 2	SAE 5	SAE 8
"A"	Torque lb/ft	Torque lb/ft	Torque lb/ft
1/4	6	9	12
5/16	10	19	27
3/8	20	33	45
7/16	30	53	75
1/2	45	80	115
9/16	70	115	15
5/8	95	160	220
3/4	165	290	400
7/8	170	410	650
1	225	630	970

Torque figures indicated above are valid for non-greased or non-oiled threads and heads unless otherwise specified. Therefore, do not grease or oil bolts or cap screws unless otherwise specified in this manual. When using locking elements, increase torque values by 5%

- Torque value for bolts and cap screws are identified by their head markings

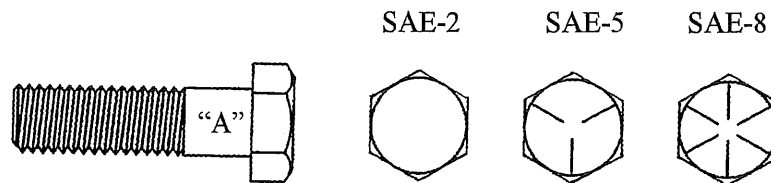

# INSTALLATION INSTRUCTIONS

## Truck Box Mounting Instructions:

1. Determine and mark on truck frame where the front of box is to be located
2. Measure truck frame length and axle position. Shorten or add to truck frame as required to match box dimensions. The most common frame length is 155" from the back of the cab to the center trunnion between the rear axles.
3. Drill truck frame and install four mounting plates evenly down the rear 2/3 of the frame. Mount plates loosely
4. Set box on truck
5. Weld mounting plates to main rail of truck box. Multi-pass on each flat bar
6. Install spring clamps as far ahead on truck box rail as possible. One on each side

NOTE: There may be a need for a flat bar spacer between any rivets on the frame and the truck box. Place the flat bar on the frame and cut out holes around the rivets

## Mechanical and Hydraulic Drive Instructions:

1. Install PTO on transmission as per PTO Manual instructions
2. Attach hydraulic tank to the box at the hole location provided on the driver side
3. Hook up suction hose from the ball valve to the suction side of the pump
4. Install filter directly onto tank using a topside port. Note the correct flow through the filter body
5. Connect pressure hose from pump to input line on box (this line goes directly to the relief valve)
6. Connect return hose from filter housing to output line on box (this line comes directly from the hydraulic motors).
7. Fill hydraulic tank with oil
  - **Make sure the ball valves are open before the PTO is started**
  - Check oil level during startup procedures

**NOTE: Install as much of these parts as possible to the truck before the box is mounted**

8. Mount control console into cab of truck
  - Connect and install PTO Air Shift control, using instructions supplied by the PTO manufacturer
  - Run wire from the electric switch in control panel to rear of box and connect to air solenoid valve (air operated rear doors), or to hydraulic solenoid valve (hydraulic operated rear doors)
9. Follow start up procedure on Initial Start Up

## STARTUP PROCEDURE

1. Engage PTO and set motor to idle. Be sure rear doors are open before engaging the PTO (to first verify that the floor chains are running in the right direction)
2. Watch floor chains for smooth operation
3. Watch floor drive chains for smooth operation
4. After a twenty-minute break-in period, check all chains
  - **Note: New chains need to “set in” and require frequent re-tensioning**
5. Replace all guards and covers.
  - **Never operate the machine without guards and covers in place**
6. Shut off machine before performing any adjustments or lubrication



**AVOID SERIOUS INJURY – DO NOT ENTER BOX WHEN INITIAL START UP IN PROCESS  
OR WHILE FLOOR CHAIN IS MOVING**

## NOTES

# ***PARMA***<sup>®</sup>

---

## **Forage Box**

**PARTS CATALOG**

---

Manual Number 030609-BOX

***PARMA***  
***COMPANY***

P.O. BOX 190  
PARMA, IDAHO 83660  
PHONE (208) 722-5116 FAX (208) 722-6012  
Website: [www.parmacompany.com](http://www.parmacompany.com)  
E-Mail: [parmacom@parmacompany.com](mailto:parmacom@parmacompany.com)





# TABLE OF CONTENTS

HYDRAULIC COMPONENTS .....	1
REAR DOOR ASSEMBLY.....	3
FLOOR CHAIN DRIVE ASSEMBLY .....	5
DECAL GROUP .....	7
BOX MOUNTING PARTS.....	9

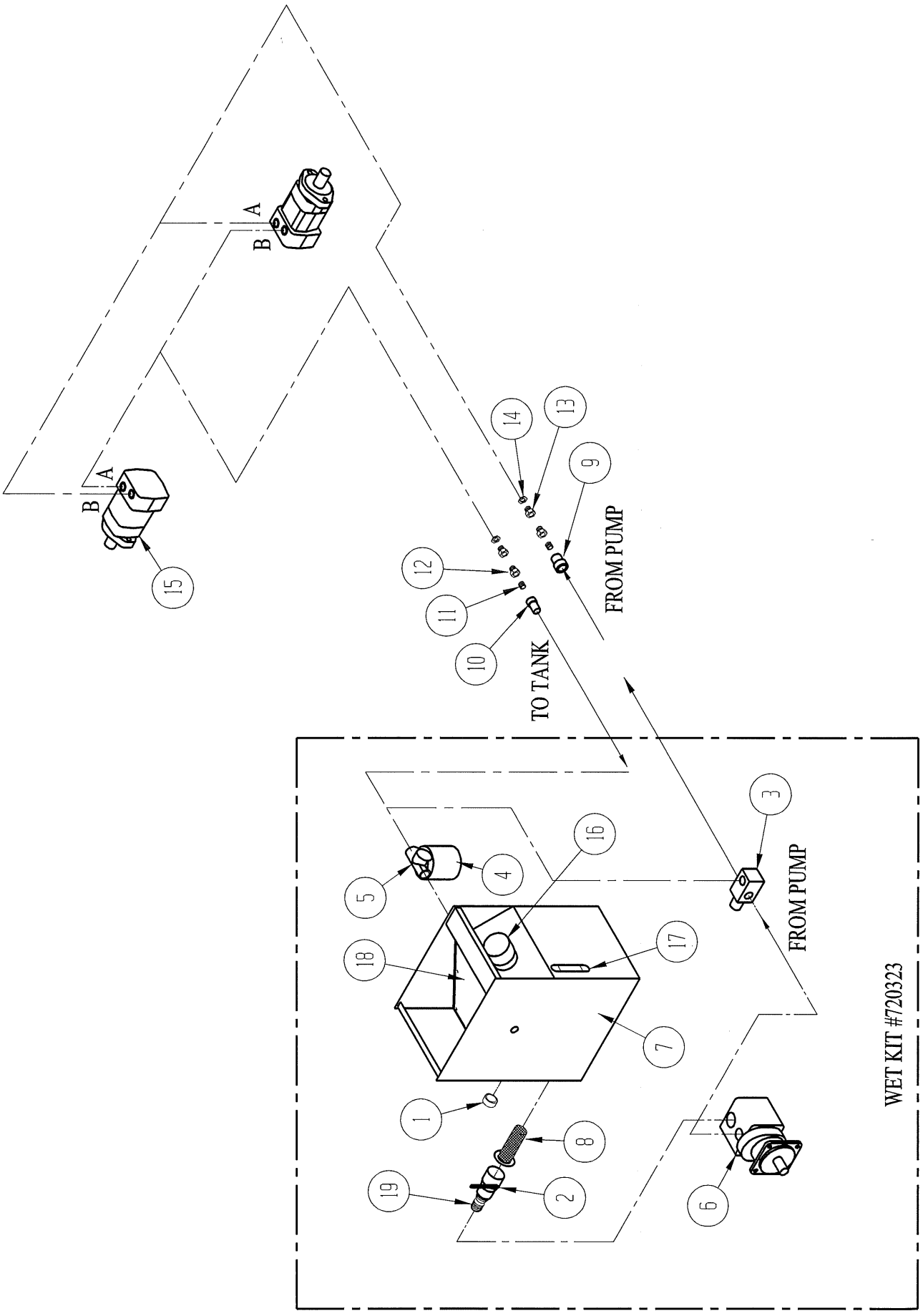

## HYDRAULIC COMPONENTS

ITEM NO.	QUANTITY	PART NO.	DESCRIPTION
1	1	-----	Pipe Plug, 1 ½ NPT
2	1	250183	Ball Valve, 1 ½"
3	1	264886	Relief Valve (See Below)
	1	264887	Relief Valve Cartridge Only
4	1	700225	Filter Element
5	1	700226	Filter Head
6	1	701224	Hydraulic Motor
7	1	700565	Hydraulic Reservoir
8	1	700230	Suction Strainer, 1 ½"
9	2	H8-62	Quick Coupler, Female
10	2	H8-63	Quick Coupler, Male
11	2	-----	Pipe Nipple, 1" NPT
12	2	0201-16-12	Reducing Adapter
13	2	0253-12-12	Bulkhead Fitting
14	2	53N-12	Lock Nut
15	2	311092	Hydraulic Motor
16	1	700227	Cap Assembly
17	1	700231	Sight Gauge
18	1	700036	Cover Plate
19	1	290108	King Nipple, 1 ½"

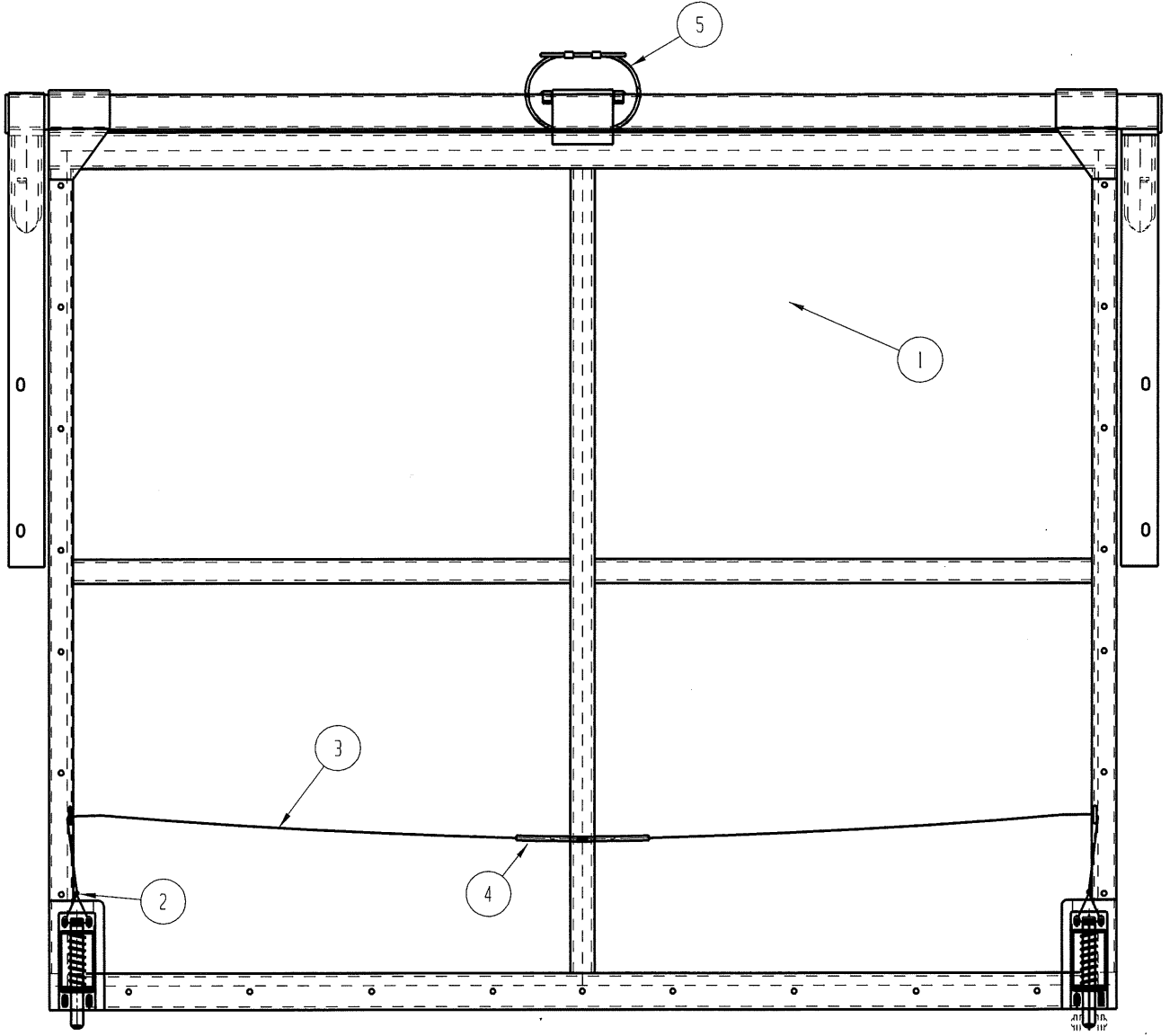

## REAR SWING DOOR

ITEM NO.	QUANTITY	PART NO.	DESCRIPTION
1	1	720722	Tailgate, Swing 5'
2	1	701572	Clamp, Cable ¼" w/2-nut Clamp
3	1	720956	Cable, Galv. ¼ x 114"
4	1	700233	Tube, ¼"
5	1	700266	Cable Galv. ¼ x 30"

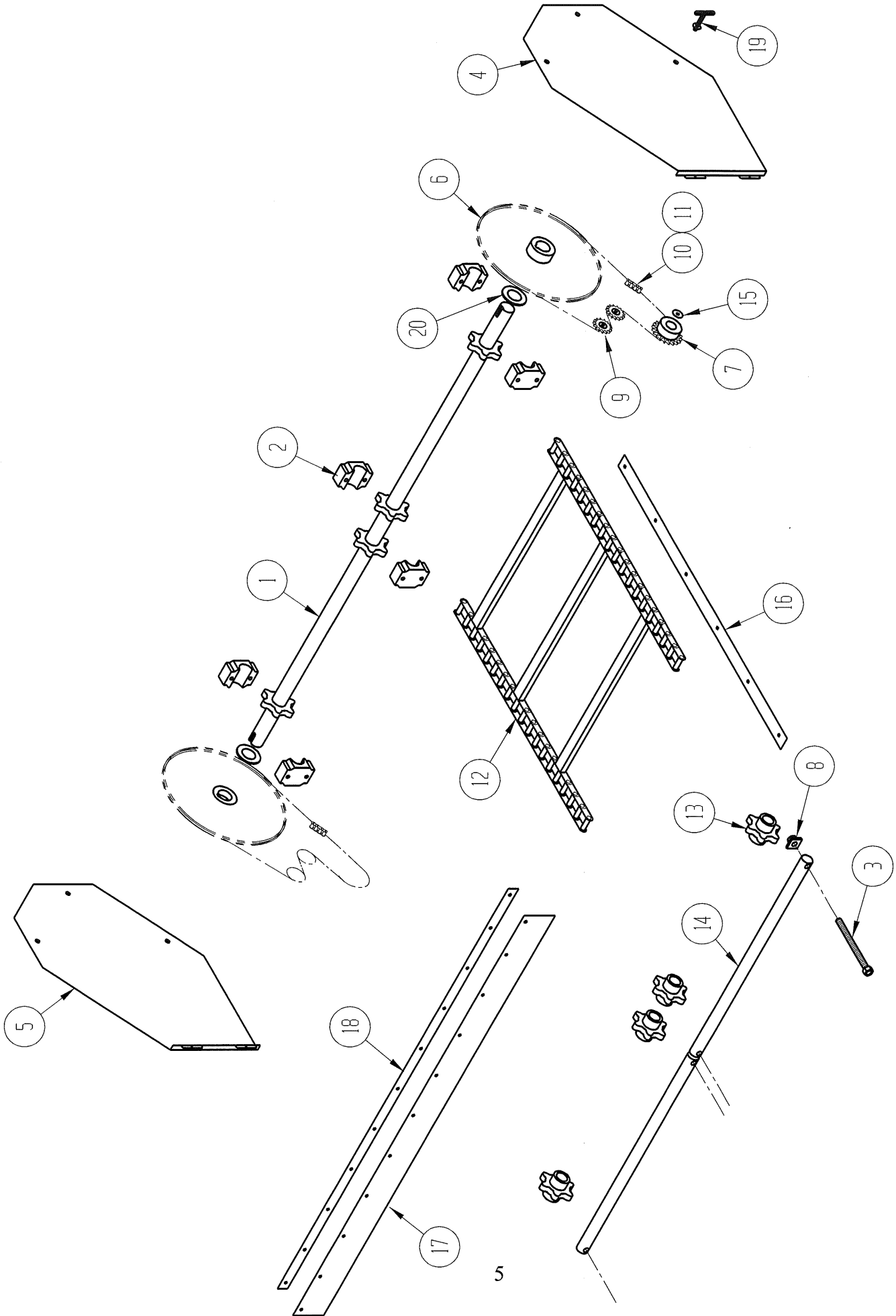

## FLOOR CHAIN DRIVE ASSEMBLY

ITEM NO.	QUANTITY	PART NO.	DESCRIPTION
1	1	720057	Floor Shaft
2	3	700397	Floor Drive Bearing
3	4	720054	Adjusting Bolt
4	1	720065	LH Drive Door
5	1	720066	RH Drive Door
6	2	720249	Sprocket, 80C70 Tooth
7	2	701212	Sprocket, 80B11 Tooth
8	4	700129	Tensioner Nut
9	4	980751	Idler Sprocket, RC80 12 Tooth
10	2	980912	Roller Chain, RC80 96"
11	2	980927	Master Link, RC80
12	8	720055	Floor Chain Section, 10 Ft.
13	4	700246	Idler Sprocket, 1 15/16 Bore
14	2	720053	Front Idler Shaft
15	2	-----	Fender Washer, 3/8
16	4	720306	Chain Runner
17	1	720036	Slope Panel Seal
18	1	720037	Slope Seal Bar
19	1	700398	Latch Key
20	2	720375	Hub Spacer

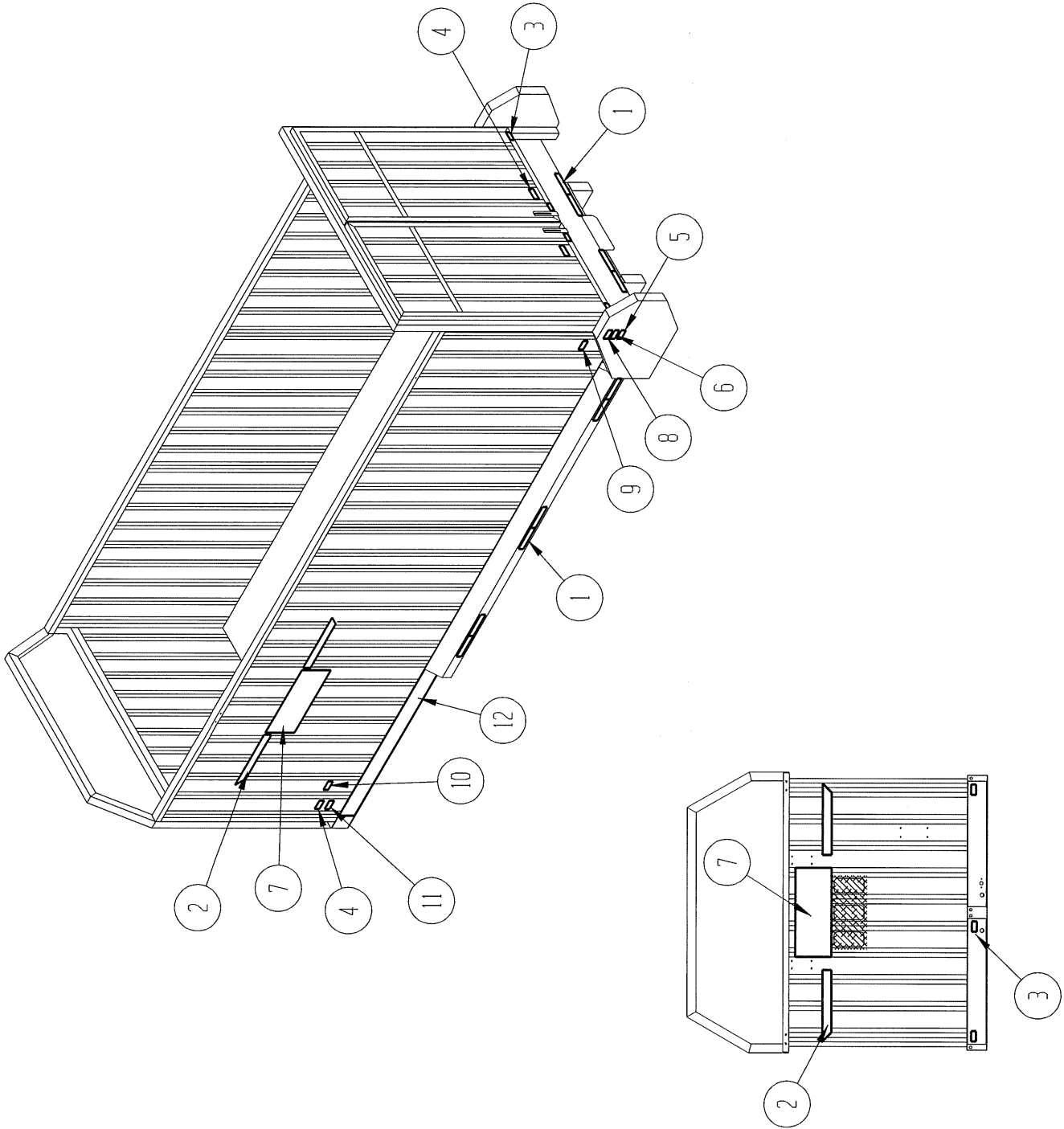



## DECAL GROUP

ITEM NO.	QUANTITY	PART NO.	DESCRIPTION
1	8	700495	Reflective Tape, 2 x 22"
2	6	700499	Decal, Stripe
3	7	700497	Decal, Grease Gun
4	4	700493	Decal, Do Not Enter
5	2	700492	Decal, Lubricate
6	2	700500	Decal, Turn Engine Off
7	3	700167	Decal, Parma
8	2	700498	Decal, Chain Lube
9	2	700502	Decal, Replace Shields
10	2	700489	Decal, Adjust Chains
11	2	700491	Decal, Grease Entire Machine
12	2	700563	Decal, Yellow Strip - 231"

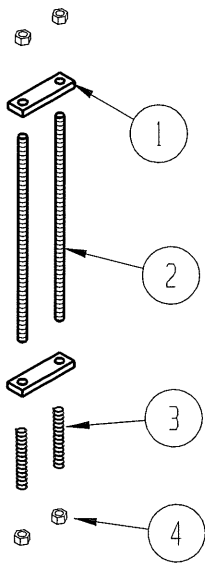
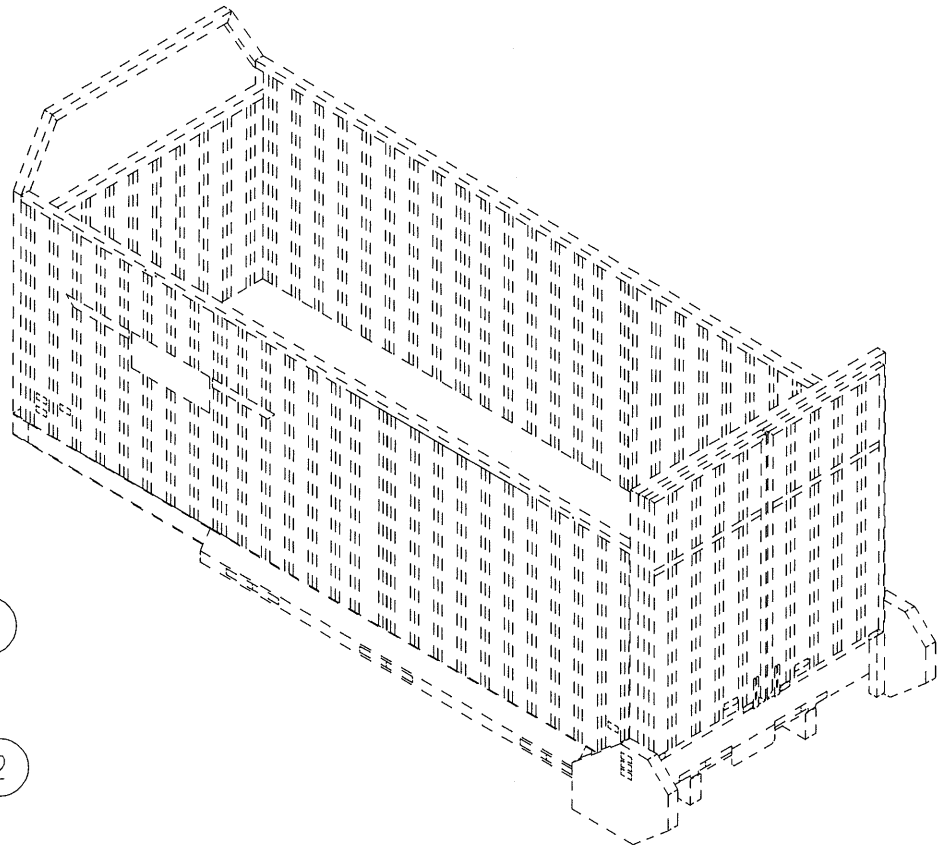

**BOX MOUNTING PARTS**

ITEM NO.	QUANTITY	PART NO.	DESCRIPTION
1	4	700141	Clamp Bar
2	4	700272	Clamp Rod
3	4	700203	Spring
4	8	-----	Lock Nut, 7/8

## NOTES